





Please read these instructions prior to installing and using your crop lifters.

-  **NOTICE:** If the combine operator experiences any difficulty during installation due to a rock guard system on the header, please contact the Flexifinger Sales & Support Team for additional instruction.
-  **CAUTION:** Never install a bolt and/or set screw in the hole at the top of the lifter rail to create a snug fit on the guard. The lifter must remain free to move and to free-float about 1/4"/6mm to 1/2"/13mm up, down and side-to-side. The use of a set screw in the hole in the top of the lifter rail may result in damage to the lifter, knife system or equipment.
-  **WARNING:** FLEXXIFLOAT™ LIFTERS ARE MADE OF STEEL AND WILL NOT BEND. Use extreme caution when traveling over irrigation ruts, sprayer and tractor ruts, large cracks in the ground and other uneven ground conditions. Digging the lifters into the ground can cause severe damage to your equipment as well as your lifters.
-  **WARNING:** Wear the proper safety equipment (gloves, protective eyewear) when installing and removing the crop lifters from the header. The components may become sharp due to wear from plant material.
-  **CAUTION:** Ensure there is adequate clearance for the knife system after installing each lifter. Not having proper clearance between the lifter and the knife system may result in equipment damage and/or injury.



1. Install the shoe onto the lifter arm.

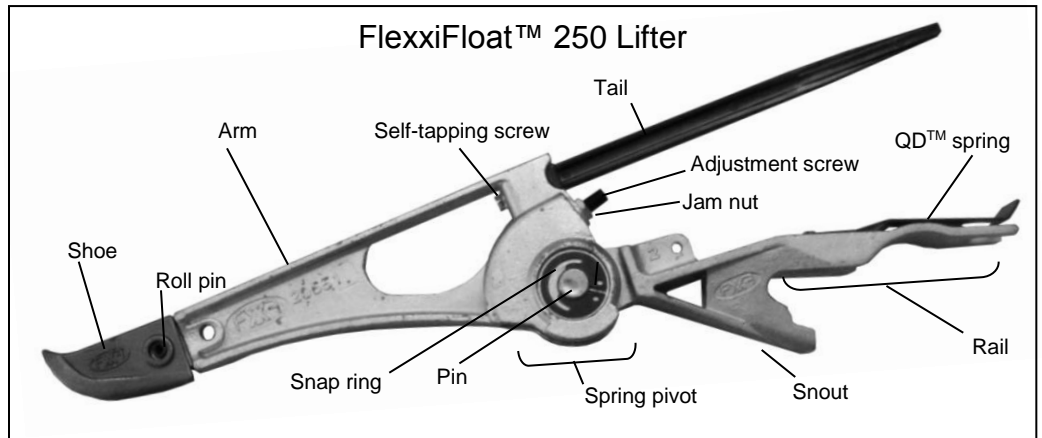
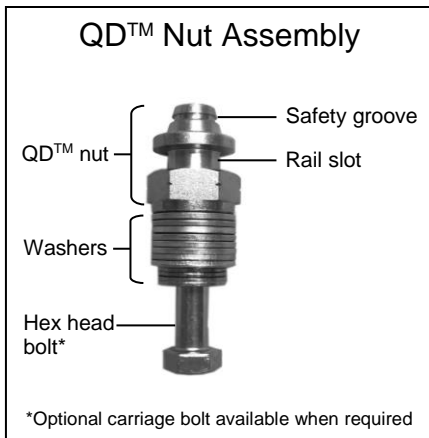

- a. Slide the shoe onto the tenon (projection) at the tip of the arm. Once the shoe reaches the end of the tenon, the holes on the shoe and tenon will line up.



- b. Insert the roll pin into the hole of the shoe. Using a hammer, pound the roll pin into the hole until the end of the roll pin is flush on either side of the shoe. If installing the 20235 2-hole long shoe, repeat this step for installing the other roll pin.

2. Install the tail onto the lifter arm.



NOTE: These FlexxiFloat™ Crop Lifters have been left with the tail removed so that you have the option to use the crop lifter with or without the tail. The tail can provide additional lift in lighter crop situations but is not recommended when harvesting heavy crops. Refer to Step 9.

- a. Tighten the rail of the crop lifter in a vise. Insert the tenon of a nylon finger into the slot at the back of the arm, with the rounded step of the tail fitting into the groove. Insert the self-tapping screw into the hole on the other side of the arm. Using a drill or impact outfitted with an extension and a 5/16"/8mm socket, drill the screw into the tail.

3. Install the QD™ Nut assembly on the header.

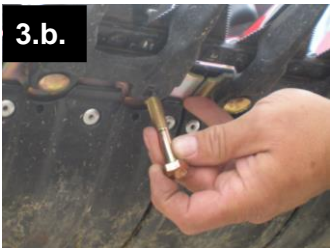

- a. Starting 12"/30cm from the right side of the header and every 12"/30cm across the header, remove the guard nut and bolt from the guards. (Please note that the setup for crops seeded in rows requires specialized spacing. Please contact us for setup instructions in this case.)

- b. Insert the 10mm x 55mm bolt from the bottom of the header.

NOTE: Optional carriage bolts are available for headers that are designed to use a carriage bolt on the underside of the guard. For headers that accept a 7/16 carriage bolt, which are generally used on MacDon, Case and New Holland headers, use optional carriage bolt part number 32312. For MacDon headers equipped with poly skid plates, such as the MacDon FD70 & FD75, use optional carriage bolt part number 32310. Some other makes of headers will use a 10mm carriage bolt, part number 32314.

- c. Place washers of the appropriate size and numbers onto the protruding bolt. Install and correctly adjust by adding or subtracting washers to one QD™ Nut assembly prior to completing the installation on the entire header. This will save you time if you need to adjust the amount of washers.

- i. For Case IH, MacDon and New Holland headers with guard #86615982, use 4 to 8 (generally 6) USS washers (the larger washer). John Deere guard #H213405 uses 1 - 4 USS washers on top of the cast knife hold-down.
- ii. For John Deere guard #H213398 (stubby guard) on HydraFlex™ headers, use 1 - 4 of the USS washers above the knife hold-down. For Schumacher guards, use about 4 SAE washers (the smaller washers) above the header on top of the guard.

- d. Thread on the QD™ nut. Repeat until all QD™ nuts are installed on the header.

- e. Take one crop lifter and install on the QD™ nut. (See Step 5. for details on installing the lifter on the QD™ nut.) Push up on the lifter so the bottom of the guard touches the bottom of the snout and observe if the rail is relatively parallel to the guard. If not, add or remove washers until it is.

For headers that require a carriage bolt, in the event that the carriage bolt (32310, 32312 or 32314) was not purchased, it is possible to mimic the step to accommodate the poly skid plate with the hex-head bolt that is included with the QD™ nut assembly.

FOR MACDON HEADER WITH POLY SKID PLATE (32310):

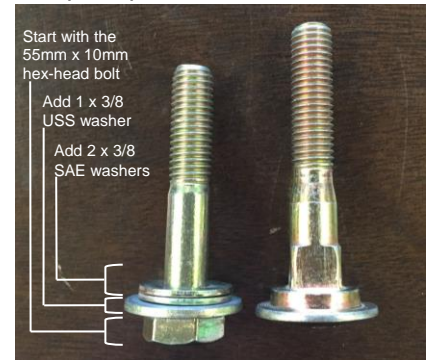

FOR ANY OTHER HEADER REQUIRING A CARRIAGE BOLT (32312 & 32314):



NOTE: Using the above configurations, the hex-head bolt may wear over time, in which case it will be difficult to remove without cutting or grinding it off. The hex-head may also catch plant material and rocks under the header.



- f. Install the remaining QD™ nuts on the rest of the header using the first-installed QD™ nut as a guide. When necessary to install a QD™ nut assembly on a knife hold down, the number of washers required will need to be reduced by the thickness of the knife hold down. Do not torque the QD™ nuts just yet.

4. Adjust the cutting bar to negative 5 degrees.



- a. This allows for more effective and efficient cutting of plant material.

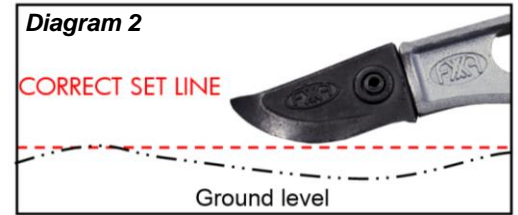

NOTE: The lifter should be set to a maximum of 25 degrees from the ground and set so in the event the shoe touches the ground the back half of the shoe will make contact as shown in diagram 2. Generally speaking, less of an angle is usually better for lifting the plant. Ideally, the lifter should be set so the tip of the shoe is about 1/2"/13mm to 3/4"/19mm above the ground.

5. Install the lifters on the header.



- a. Slide the lifter snout over the guard with the rail spring side up. Push the lifter rail into the rail slot on the QD™ nut. The rail spring will pop into place under the safety groove. See Diagram 3 and 4. Install lifters on all remaining QD™ nuts and check each lifter to ensure there is adequate clearance from the knife.

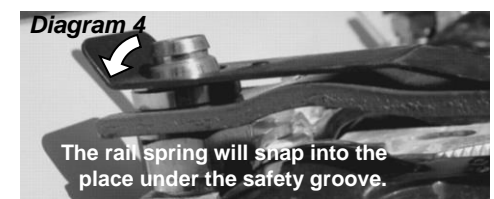
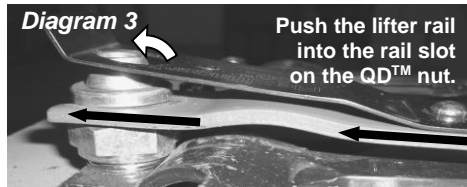

6. Check the positioning and angle of each lifter.

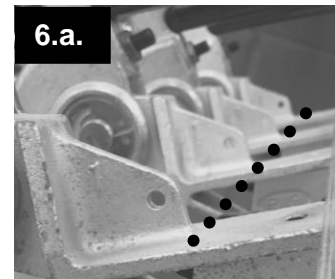

- a. Look down the length of the header and check the positioning of each lifter's accessory plate. The base of each accessory plate should form a straight line across the length of the header. On headers that may not have a perfectly straight cutting bar, further adjustments will be required.



- b. If any one lifter is not in line with the others, remove that lifter. Remove the QD™ nut and adjust the number of washers as required (either by adding or subtracting washers) so that the base of the accessory plate is level with the others. Repeat for each lifter that is not level with the others until the base of each accessory plate forms a straight line as shown in image 6.a. above.

7. Tighten all QD™ nuts to 60 ft-lb/81Nm torque.



- a. Remove all lifters and tighten all QD™ nuts to 60ft-lb/81Nm torque. Once installed, the QD™ nuts can remain on the header.

8. Limit the adjustment screw and jam nut.

NOTE: The adjustment screw limits the amount of downward travel of the spring pivot in the event the lifter encounters an obstacle. Incorrectly adjusting the adjustment screw and jam nut in such a way that the spring movement is over-constrained increases the likelihood of damage to the lifter and/or equipment. If the factory preset adjustment does not appear to be correct for your conditions, please contact Flexifinger's Support Team for advice.



a. Find the part number of the rail. The number is located on the snout.

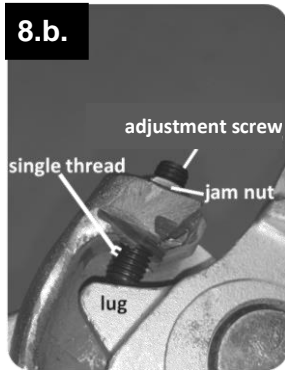

b. Turn the adjustment screw to adjust the lifter to the desired angle, keeping in mind that a half-turn of the adjustment screw affects the downward travel angle of the lifter by about 5 degrees. The recommended approximate minimum set screw adjustment is outlined in the chart below:

RAIL PART NUMBER	RECOMMENDED APPROXIMATE MINIMUM ADJUSTMENT
20043	Turn set screw until it is touching the stopping lug. Then turn in 3 more threads.
20046	Turn set screw in most of the way leaving only about 4 threads exposed beyond the jam nut.
20047	Turn set screw until it is touching the stopping lug. Then turn in 2 more threads.

9. Combine 100 feet. Re-adjust the lifters as required.



a. Whenever possible prior to installing the crop lifters on the header, combine approximately 100 feet without the lifters to adjust the header angle, reel speed/height, header height, etc. to achieve optimal settings of the header alone. Once the lifters are installed, drive slowly over the path that has been harvested and observe whether or not the lifters need to be adjusted.

NOTE: A heavy crop may push down on the tail causing the tip to lift over the crop. In this situation, the solutions are as follows:

IN DRY SOIL CONDITIONS:

- Swap out the factory-installed spring for the heavier spring included in the original packaging.
- If changing the spring did not fix the situation, remove the tail.

IN WET SOIL CONDITIONS:

- Remove the tail.

To change the factory-installed spring:

- Remove the snap ring by spreading it only enough to slide it over the pivot pin.
- Remove the pivot pin and disconnect the lifter rail from the lifter arm.
- Slide the factory-installed spring and nylon bushing out of the arm cavity. Note that the longer end of the spring is inserted into a small hole at the front of the cavity.
- Insert the nylon bushing into center of the heavier spring and insert the longer end of the heavier spring into the small hole in the arm cavity.
- Fit the lifter rail and the arm pieces together and re-insert the pivot pin.
- Spread the snap ring apart and slide over the pivot pin to re-attach. Take care to not over-extend the snap ring.

10. To remove the lifters:

- Lift the QD™ spring high enough to clear the top of the QD™ nut.
- Pull the lifter rail forward to slide the rail out of the slot on the QD™ nut.
- Continue to pull the lifter off until the rail is clear of the QD™ nut.



Flexifinger QD Industries Inc. and/or its subsidiary Flexifinger USA Inc.
Corporate Head Office: Box 1599, Assiniboia SK Canada S0H 0B0, 306-642-4555

WWW.FLEXXIFINGER.COM